

SPECIFICATIONS

DIAMETER:	10" (254.0 mm)
SENSITIVITY (2.83 V @ 1 m):	90 dB
POWER HANDLING:	275 W _{RMS}
FREQUENCY RESPONSE:	20 ~ 500 Hz
NOMINAL IMPEDANCE:	8 OHMS
VOICE-COIL DIAMETER:	2.0" (50.7 mm)

DIMENSIONS:

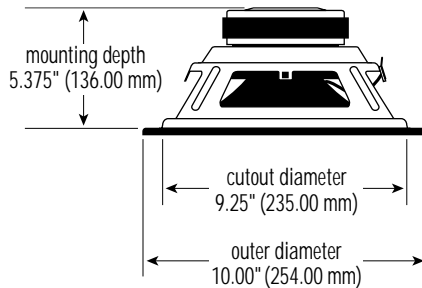

THIELE-SMALL PARAMETERS

VOICE COIL DC RESISTANCE:	R_{EVC} (OHMS)	7.56
VOICE COIL INDUCTANCE @ 1 kHz:	L_{EVC} (MH)	1.73
DRIVER RADIATING AREA:	S_D (IN ²)	55.02
	S_D (CM ²)	355.00
MOTOR FORCE FACTOR:	BL (TM)	13.98
COMPLIANCE VOLUME:	V_{AS} (FT ³)	3.17
	V_{AS} (LITERS)	89.73
SUSPENSION COMPLIANCE:	C_{MS} (µM/N)	501.37
MOVING MASS, AIR LOAD:	M_{MS} (GRAMS)	60.61
MOVING MASS, DIAPHRAGM:	M_{MD} (GRAMS)	56.76
FREE-AIR RESONANCE:	F_S (Hz)	28.87
MECHANICAL Q:	Q_{MS}	6.55
ELECTRICAL Q:	Q_{ES}	0.43
TOTAL Q:	Q_{TS}	0.40
MAGNETIC-GAP HEIGHT:	H_{AG} (IN)	0.31
	H_{AG} (MM)	7.92
VOICE-COIL HEIGHT:	H_{VC} (IN)	1.25
	H_{VC} (MM)	31.75
MAXIMUM EXCURSION:	X_{MAX} (IN)	0.47
	X_{MAX} (MM)	11.91

SEALED BOX VOLUME (INCLUDES DRIVER DISPLACEMENT)

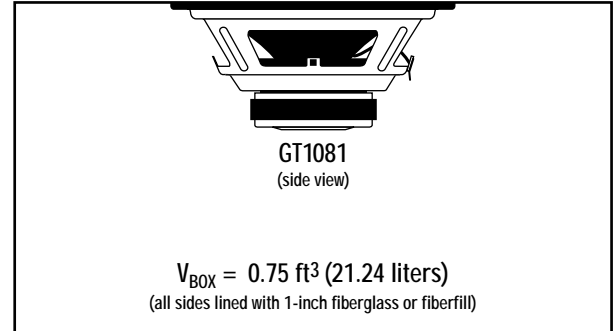

SEALED FREQUENCY RESPONSE @ 2.83 V

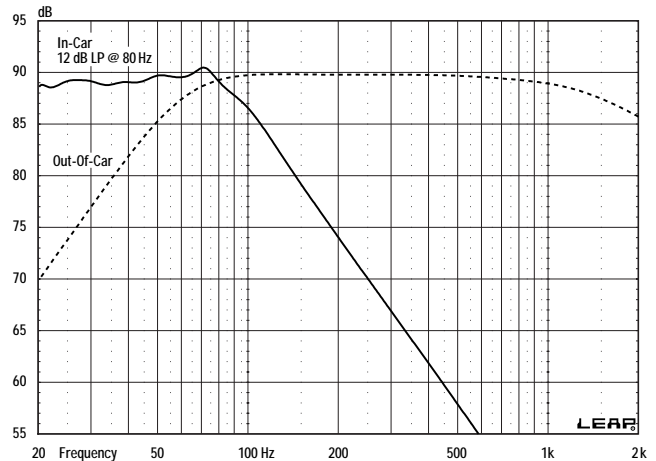

SEALED EXCURSION/GROUP DELAY @ 300 W

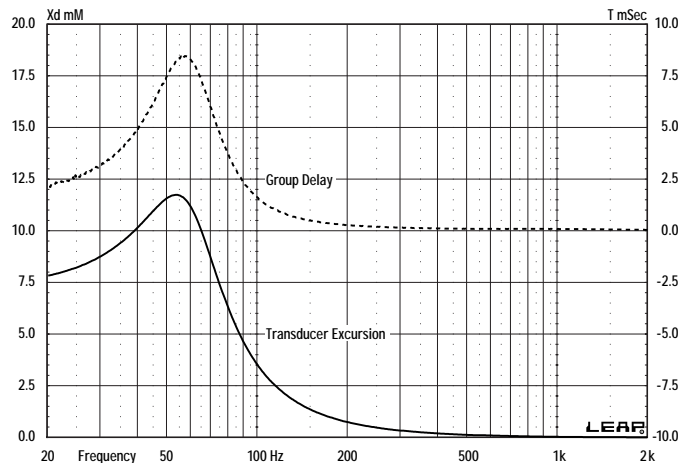



GT1081 10" Woofer – Technical Data

VENTED BOX VOLUME (INCLUDES DRIVER/PORT DISPLACEMENTS)

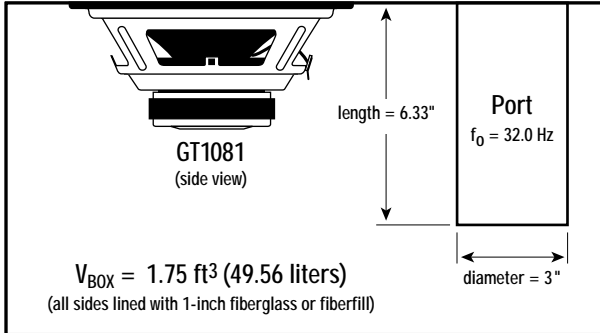

SEALED BANDPASS BOX VOLUME (INCLUDES DRIVER/PORT DISPLACEMENTS)

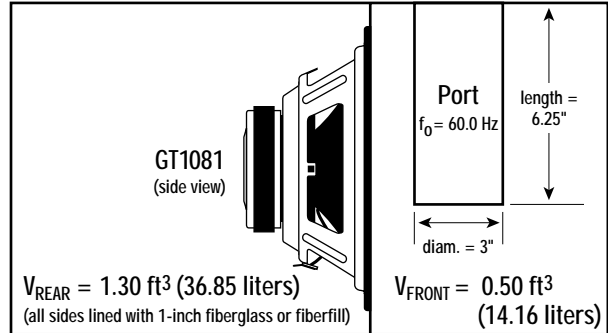

VENTED FREQUENCY RESPONSE @ 2.83 V

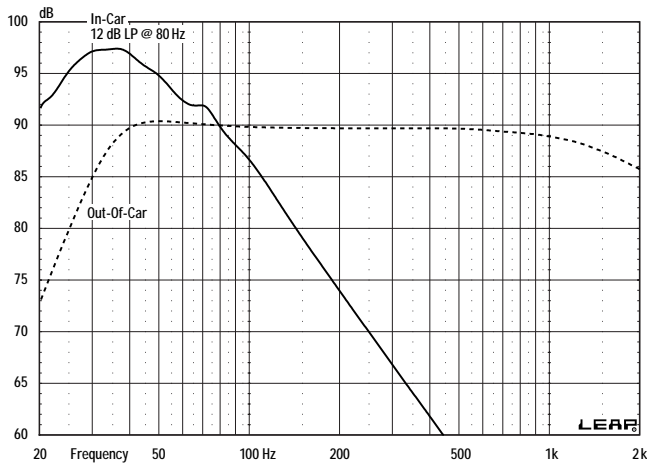

SEALED BANDPASS FREQUENCY RESPONSE @ 2.83 V

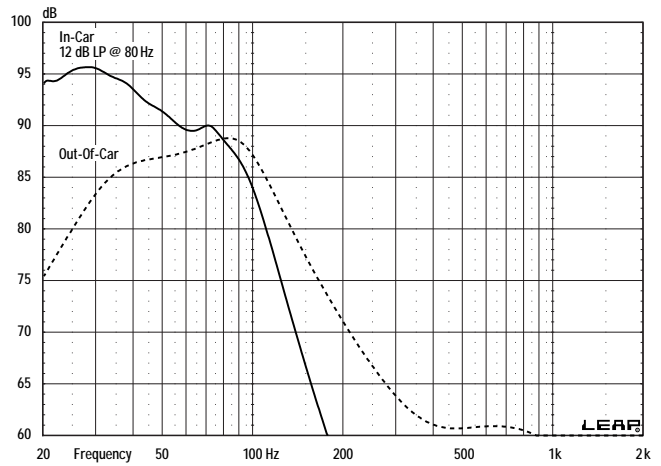

VENTED EXCURSION/GROUP DELAY @ 350 W

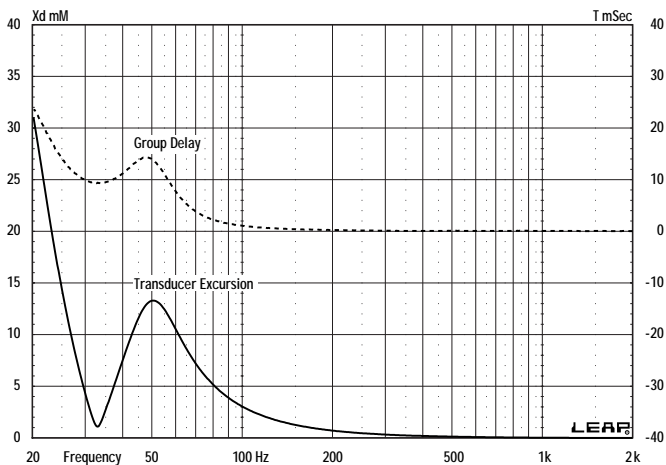

SEALED BANDPASS EXCURSION/GROUP DELAY @ 325 W

